



HHSC IMAGING SUITES

SUBSTITUTION REQUESTS

1.20.2023



TABLE of CONTENTS

- SMMH Imaging Suites Requested
Product Substitutions Pages 3-15
- KVMH Imaging Suites Requested
Product Substitutions Pages 13-16

Project Name: SMMH Imaging Suites

Project #: 220038-01

Specified Item: Herman Miller Canvas Wood Freestanding Bookcase



Natural Maple
Grade L1



As Pictured

PROPOSED SUBSTITUTION

Description: Approach Freestanding Bookshelf with (2) adjustable shelves

Manufacturer: Allsteel

Model #: WKBKFN3H3015

Dimensions: 30"W x 15"HD x 42-1/2"H

Content/Materials: Woodgrain Laminate

Quantity: 1

Finish: Natural Maple

G70 REJECTED. MATCH ORIGINAL DIMENSIONS. FINISH ALSO REJECTED. IF SELECTED, PHYSICAL SAMPLES OF FINISHES NEEDED FOR APPROVAL.

PEDESTAL STORAGE

CG-03

Project Name: SMMH Imaging Suites

Project #: 220038-01

Specified Item: Herman Miller Canvas Landscape Freestanding Pedestal

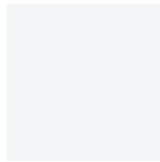

Designer White
with Platinum
Metallic



Natural Maple
Grade L1



Designer White
with Platinum
Metallic



As Pictured

PROPOSED SUBSTITUTION

Description: Involve Freestanding Pedestal with **metal leg**, full extension glides, bar pull, (2) keys, keyed alike per area. Accommodates front to back filing.

Manufacturer: Allsteel

Model #: K2T241824BF

Dimensions: **18"W** x 24"HDx 24"H

Content/Materials: Woodgrain Laminate

Quantity: 2

Finish: **Natural Maple** drawer fronts and Designer White with Platinum Metallic pulls and feet

Project Name: SMMH Imaging Suites

Project #: 220038-01

Specified Item: Herman Miller Sayl Work Chair

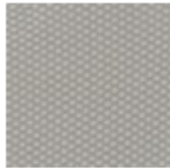

Loft



Titanium



PROPOSED SUBSTITUTION

Description: Mimeo Work Chair with knit back, 4D arms with lumbar support. Black multi-surface casters. Warranted up to 350 pounds.

Manufacturer: Allsteel

Model #: MIW-KWNO

Dimensions: 23-3/4"W x 23-3/4"D x 36-1/4"-41-1/4"H

Quantity: 11

Finish: COM upholstery Maharam Ledger Marsh, **Titanium** frame and 5-star base, White back carrier, **Loft knit color**

G70 REJECTED. BACK TO BE NON-WOVEN AND CLEANABLE AS SPECIFIED.

Project Name: SMMH Imaging Suites

Project #: 220038-01

Specified Item: Herman Miller Caper Chair



White



Silver



PROPOSED SUBSTITUTION

Description: Lyric Stacking chair with perforated polypropylene molded back and seat. Tubular steel leg. Armless. Warranted up to 300 lbs.

Manufacturer: Allsteel

Model #: CMPN-PPGANO

Dimensions: 24"W x 20-1/2"D x 34"H

Quantity: 3

Finish: White seat and back. Silver frame.

Project Name: SMMH Imaging Suites

Project #: 220038-01

Specified Item: Steelcase Move Chair

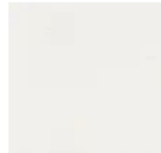

White



Silver



PROPOSED SUBSTITUTION

Description: Inspire Tubular steel leg and frame. Armless. Warranted up to 300 lbs. Can stack 5 high,

Manufacturer: Allsteel

Model #: INST-SGANO

Dimensions: 24"W x 22-3/4"D x 34"H

Quantity: 6

Finish: White seat and back. Silver frame. CF Stinson Route Stone upholstered seat.

ROUND MEETING TABLE—30"

T-01

Project Name: SMMH Imaging Suites

Project #: 220038-01

Specified Item: Herman Miller Everywhere Table

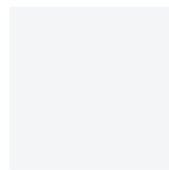

Designer White
Specified



Silver



PROPOSED SUBSTITUTION

Description: Dining height round table with 4-leg X base. **TFL top with knife edge.**

Manufacturer: Allsteel

Model #: AMPTLK30RND, AMPTXM29GP

Dimensions: 30"DIAM x 29"H

Quantity: 2

Finish: Designer White top with Silver column and Polished Aluminum legs

CAFE TABLE—36"

T-02

Project Name: SMMH Imaging Suites

Project #: 220038-01

Specified Item: Herman Miller Everywhere Table

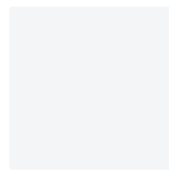

Designer White
Silver



Silver



PROPOSED SUBSTITUTION

Description: Dining height round table with 4-leg X base. **TFL top with knife edge.**

Manufacturer: Allsteel

Model #: AMPTLK36RND, AMPTXM29GP

Dimensions: 36"DIAM x 29"H

Quantity: 1

Finish: Designer White top with Silver column and Polished Aluminum legs

Project Name: SMMH Imaging Suites

Project #: 220038-01

Specified Item: Nemschoff Palisade Tote with Top

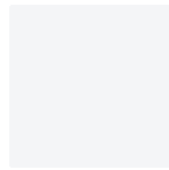

Blazing.com
Nemschoff



Silver



PROPOSED SUBSTITUTION

Description: Involve Open Shelf with metal legs

Manufacturer: Allsteel

Model #: KL281818A, KLCW218

Dimensions: 28"H x 18"W x 18"D

Quantity: 2

Finish: Designer white laminate with Silver legs

Project Name: SMMH Imaging Suites

Project #: 220038-01

Specified Item: Herman Miller Canvas Landscape Rectangular Desk

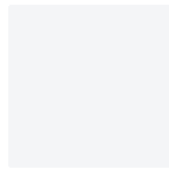

Designer White
Top



Silver

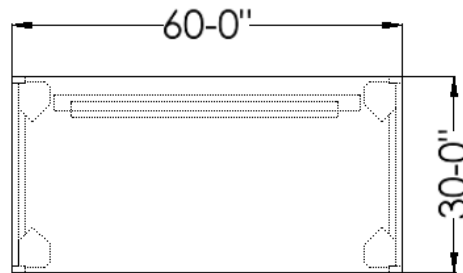

PROPOSED SUBSTITUTION

Description: Freestanding workstation with TFL top and sculptural metal **O leg**. No grommets. Adjusting leveling glides.

Manufacturer: Allsteel

Model #: AMPTLK36RND

Dimensions: 60"W x 30"D x 30"H

Quantity: 2

Finish: Designer White top with Silver legs

Project Name: SMMH Imaging Suites

Project #: 220038-01

Specified Item: Herman Miller Canvas Landscape Workstation

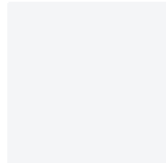

Designer White
Sonic L1



Silver



Natural Maple
Grade L1



Coast

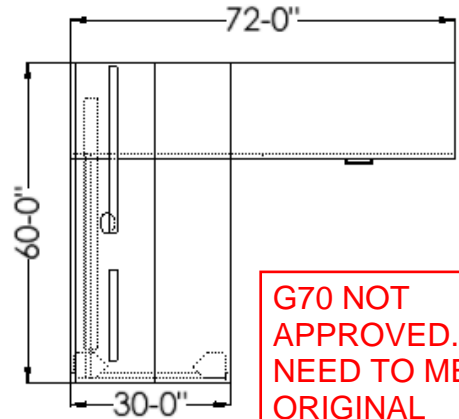
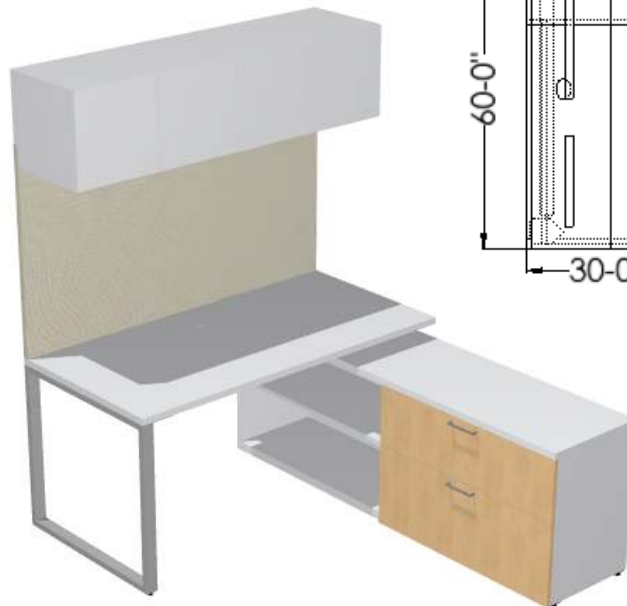

G70 NOT APPROVED. NEED TO MEET ORIGINAL DIMENSIONS. FINISHES NOT APPROVED. IF SELECTED, NEED TO SUBMIT PHYSICAL SAMPLES.

PROPOSED SUBSTITUTION

Description: Approach TFL worksurface with metal O leg and support credenza with open shelves and drawers. Tackboard above worksurface with wall-mount hinged door lockable overhead

Manufacturer: Allsteel

Model #: WKWSRS6030, WKCUTN247218-OSBF, WKTKFT4H60-LA, WKOH156015-HDL

Dimensions: 60"W x 72"D x 30"H

Quantity: 2

Finish: Designer White top with Silver legs and Natural Maple drawer fronts and Coast Shoal tackboard fabric

Project Name: KVMH Imaging Suites

Project #: 220038-01b

Specified Item: Herman Miller Sayl Work Chair

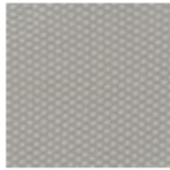

Loft



Titanium



PROPOSED SUBSTITUTION

Description: Mimeo Work Chair with knit back, 4D arms with lumbar support. Black multi-surface casters. Warranted up to 350 pounds.

Manufacturer: Allsteel

Model #: MIW-KWNO

Dimensions: 23-3/4"W x 23-3/4"D x 36-1/4"-41-1/4"H

Quantity: 9

Finish: COM upholstery Maharam Ledger Marsh, **Titanium** frame and 5-star base, White back carrier, **Loft knit color**

G70 REJECTED. BACK TO BE NON-WOVEN AND CLEANABLE AS SPECIFIED.

Project Name: KVMH Imaging Suites

Project #: 220038-01b

Specified Item: Herman Miller Caper Chair



Calypso



Silver



PROPOSED SUBSTITUTION

Description: Lyric Stacking chair with perforated polypropylene molded back and seat. Tubular steel leg. Armless. Warranted up to 300 lbs.

Manufacturer: Allsteel

Model #: CMPN-PPGANO

Dimensions: 24"W x 20-1/2"D x 34"H

Quantity: 2

Finish: Calypso seat and back. Silver frame.

G70 APPROVED.
IF SELECTED,
NEED PHYSICAL
SAMPLES OF
FINISHES.

Project Name: KVMH Imaging Suites

Project #: 220038-01b

Specified Item: Steelcase Move Chair

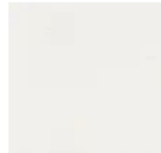

White



Silver



PROPOSED SUBSTITUTION

Description: Inspire Tubular steel leg and frame. Armless. Warranted up to 300 lbs. Can stack 5 high,

Manufacturer: Allsteel

Model #: INST-SGANO

Dimensions: 24"W x 22-3/4"D x 34"H

Quantity: 4

Finish: White seat and back. Silver frame. CF Stinson Route Stone upholstered seat.

ROUND MEETING TABLE—30"

T-01

Project Name: KVMH Imaging Suites

Project #: 220038-01b

Specified Item: Herman Miller Everywhere Table

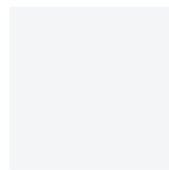

Blazing.com
2020.01.11



Silver



PROPOSED SUBSTITUTION

Description: Dining height round table with 4-leg X base. **TFL top with knife edge.**

Manufacturer: Allsteel

Model #: AMPTLK30RND, AMPTXM29GP

Dimensions: 30"DIAM x 29"H

Quantity: 1

Finish: Designer White top with Silver column and Polished Aluminum legs